

MODEL
R15s SUBWOOFER



TECHNICAL SPECIFICATIONS

APP Control - iOS and Android



Advanced APP User interface - customizable turn-on controls and input selection, multiple PEQ's with presets.

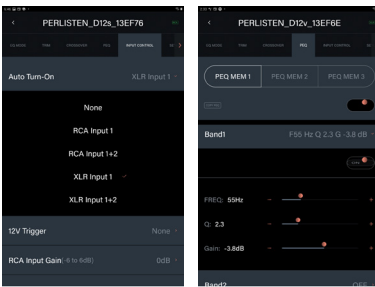

Alignment	Acoustic suspension
Amplifier	1.0kW rms
Display Interface	2.4" LCD color touchscreen
App	iOS and Android
Processor	32-bit ARM Cortex M4, double precision floating point math
DSP Engine	Ti DSP 48-bit data paths
Driver compliment	380mm, Glass fiber diaphragm +/-23.7mm linear excursion
Reference sensitivity	92dB /150mV/ 1.0m
Frequency Response	THX EQ 20-388Hz (-6dB) / 16-468Hz (-10dB) Boost (Large Room) EQ 16-388Hz (-6dB) / 14-468Hz (-10dB) Cut (Small Room) EQ 25-388Hz (-6dB) / 19-468Hz (-10dB)
Inputs	(1) Balanced XLR (1) Unbalanced RCA
Outputs	(1) Balanced XLR unbuffered (1) Unbalanced RCA unbuffered
Parametric EQ	10-Band PEQ with 3 user presets
Low Pass filter	bypass, 30-160Hz, slope 6,12,18,24dB/oct
Phase	variable 0-270°
Polarity	normal / inverted
Configurable Auto turn-on and 12v Trigger	XLR 1, RCA
Dimensions overall (HxWxD)	498 x 460 x 465mm 19.6 x 18.1 x 18.3"
Weight	35.5 kg (78.1 lbs.)

DESCRIPTION

R-Series subs - Trickle down technology from our flagship D-Series, we've developed a lineup of single driver based subwoofers. Ground up drivers developed by our team of engineers. Glass fiber composite diaphragms, multiple aluminum shorting rings, massive magnets, multi-layer Nomex spiders and lightweight aluminum voice coil wire are the key ingredients - Proprietary nonlinear modeling techniques allow us to simulate all these components and then optimize for real world driver performance - free air and in box. Further refinement is done with the aid of our Klippel laser measurement system to dial things in. Powered by our new 1.0kW amplifier, all functions and safeties are controlled by a 48-bit data bath DSP and 32-bit ARM M4 Cortex processor, able to react in microseconds ensuring sonic accuracy. All R-Series subs share our 2.4" LCD touchscreen display and ability to control advance settings using our App.

4 3 2 1

REVISIONS	
REV.	DESCRIPTION
1	initial drawing
	DATE
	20230103

D C B A

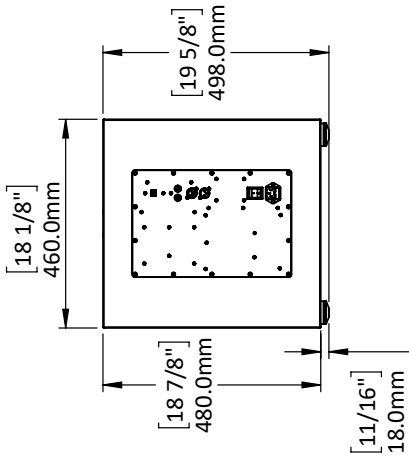
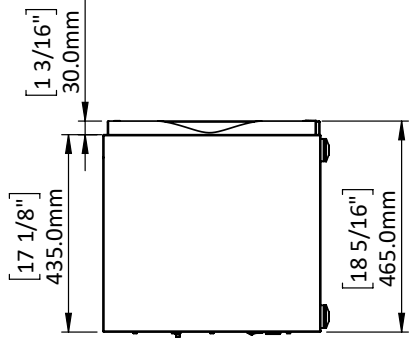
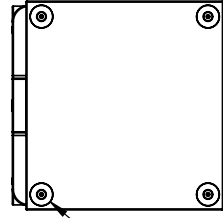
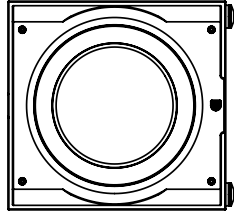
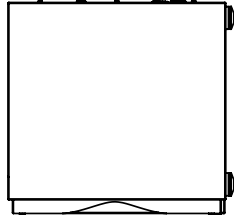
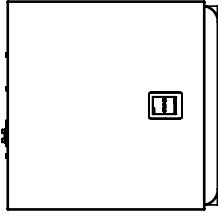
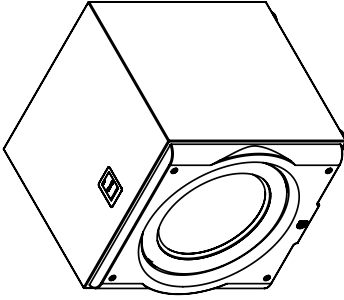

$[1 \frac{15}{16}"]$
 \varnothing 50.0mm

Notes:

PERLISTEN
perceptual learning experience

NAME: _____ DATE: 1/3/2024
 TITLE: Sheet1

PROPRIETARY AND CONFIDENTIAL
 THE INFORMATION CONTAINED IN THIS DRAWING IS THE SOLE PROPERTY OF PERLISTEN AUDIO, LLC. ANY REPRODUCTION IN PART OR AS A WHOLE WITHOUT THE WRITTEN PERMISSION OF PERLISTEN AUDIO, LLC IS PROHIBITED.
 DIMENSIONS ARE IN MILLIMETERS UNLESS OTHERWISE SPECIFIED.

SIZE DWG. NO. **A Perlisten R15s_Architectural** REV **1**
 SCALE: 1:1.5 SHEET 1 OF 1

3 2 1